



HOPE INDUSTRIAL SYSTEMS



# 19.5" PANEL MOUNT INDUSTRIAL MONITOR

## REVISION A

### USER MANUAL

Model No. HIS-ML19.5- \_\_ \_\_ A



# Table of Contents

<b>Safety and Regulatory Information</b> .....	<b>3</b>
FCC Notice .....	3
Hazardous Locations .....	4
Waste Electrical and Electronic Equipment Directive (WEEE) .....	4
<b>Mechanical Drawings</b> .....	<b>5</b>
Front and Side Views .....	5
Bottom View .....	5
Rear View .....	6
<b>Installation Instructions</b> .....	<b>7</b>
Step 1: Prepare for Installation .....	7
Step 2: Bench-test Configuration .....	8
Install Cable Connections .....	8
Install Touch Screen Driver .....	10
Step 3: Install into Panel .....	12
<b>Video Settings</b> .....	<b>14</b>
Setting the Timing Mode .....	14
Control Panel Buttons .....	15
OSD and Power Lock Settings .....	16
On-Screen Display (OSD) Menus.....	17
Auto Image Adjust Menu .....	18
Contrast / Brightness Menu.....	18
Input Select Menu .....	18
Audio Adjust Menu .....	18
Color Adjust Menu .....	19
Information Menu .....	20
Manual Image Adjust Menu.....	20
Setup Menu .....	21
Memory Recall Menu .....	22
<b>Cleaning Instructions</b> .....	<b>23</b>
<b>Troubleshooting</b> .....	<b>24</b>
Video Troubleshooting .....	24
Touch Screen Troubleshooting .....	26
<b>Specifications</b> .....	<b>27</b>
Display .....	27
Environmental .....	27
Video .....	28
Electrical .....	29
Functional .....	29
Physical .....	29
Compliances and Certifications .....	30
<b>Warranty Statement</b> .....	<b>31</b>



---

## Safety and Regulatory Information

---



### WARNING!

To prevent fire or shock hazard, do not expose live components to rain or moisture. Dangerously high voltages are present inside the unit. Do not disassemble the unit. Refer servicing to qualified personnel only. Operator could be exposed to dangerously high voltage if AC power is not connected properly. Verify all wiring is properly connected.

This equipment is not intended for use in critical applications where its failure to operate would create immediate life threatening circumstances. Applications including, but not limited to, nuclear reactor control, aerospace navigation systems and life support systems are not appropriate for this product.

This product is intended to be mounted in a suitable cabinet or other enclosure. The NEMA 4, 4X, or 12 ratings are applicable only when properly installed in a like rated enclosure.

To be covered by UL 60950 3<sup>rd</sup> Edition, the socket-outlet shall be installed near the equipment and shall be easily accessible.

**DC Supplied Units only:** The HISML19.5 subject unit is to be powered by a Listed Power Supply suitable for the application with outputs at SELV/LPS or Class 2 levels rated 9.6-36.6VDC, 2.5 A max. The equipment is not intended to connect directly to a DC Mains source.

---

### FCC Notice

This equipment has been tested and found to comply with the limits for a Class A digital device, pursuant to Part 15 of the FCC Rules. These limits are designed to provide reasonable protection against harmful interference when the equipment is operated in a commercial environment. This equipment generates, uses, and can radiate radio frequency energy and, if not installed and used in accordance with the instruction manual, may cause harmful interference to radio communications. Operation of this equipment in a residential area is likely to cause harmful interference in which case the user will be required to correct the interference at his own expense. Any changes or modifications not expressly approved by the grantee of this device could void the user's authority to operate the device.

## Hazardous Locations

This equipment is suitable for use in Class I, Division 2, Groups A, B, C, and D; Class II, Division 2, Groups F and G; Class III; or non-hazardous locations only.

Device is open-type and is to be installed in an enclosure suitable for the environment that is only accessible with the use of a tool.

FR: Cet équipement peut être utilisé dans la Classe I, Division 2, Groupes A, B, C et D; Classe II, Division 2, Groupes F et G; et Classe III, endroits hasardeux ou endroits non-hasardeux seulement. Cet appareil doit être installé dans un enclos adapté à un environnement accessible uniquement avec l'aide d'un outil.

**WARNING – EXPLOSION HAZARD –** Do not disconnect equipment unless power has been removed or the area is known to be non-hazardous.

**WARNING – EXPLOSION HAZARD –** Substitution of any components may impair suitability for Class I, II & III, Division 2 Locations.



Any steps marked with this symbol are required to ensure compliance with Class I, II, III, Division 2 Hazardous Location requirements.

## Waste Electrical and Electronic Equipment Directive (WEEE)

***The following information is only for EU-member states:***

The mark shown to the right is in compliance with the Waste Electrical and Electronic Equipment Directive 2002/96/EC (WEEE).



The mark indicates the requirement NOT to dispose of the equipment as unsorted municipal waste, but use the return and collection systems according to local law. Users should contact their supplier and check the terms and conditions of the purchase contract. When purchased directly from Hope Industrial Systems, you may contact technical support for disposal arrangements.

# Mechanical Drawings

## Front and Side Views

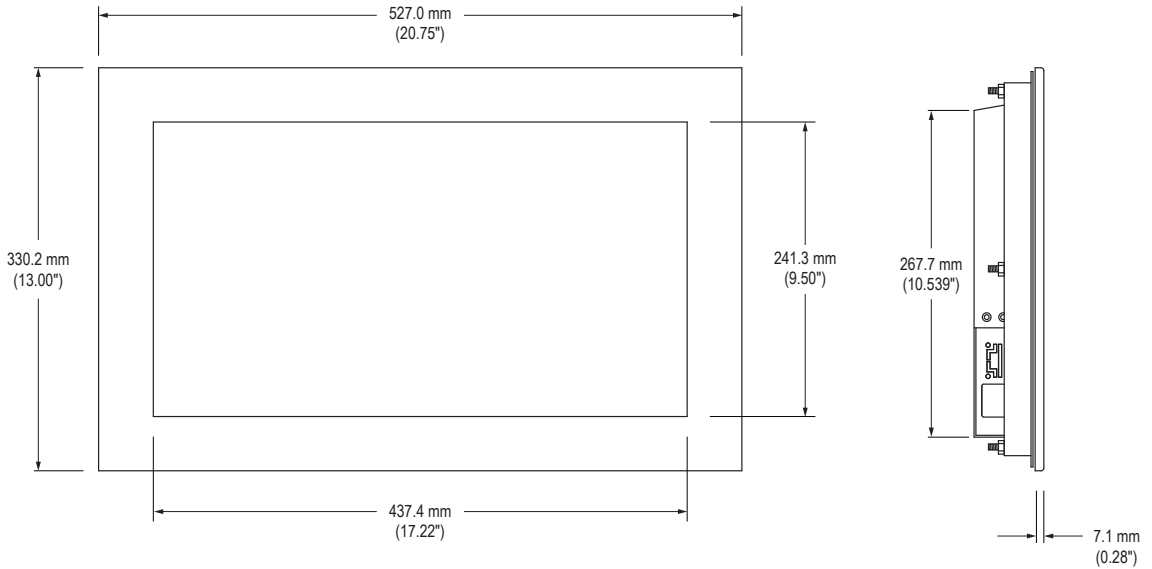

## Bottom View

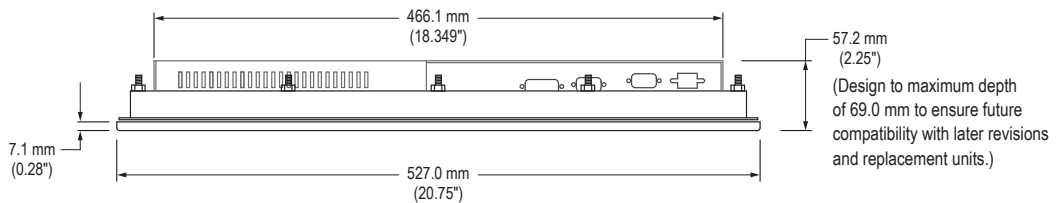

## Rear View

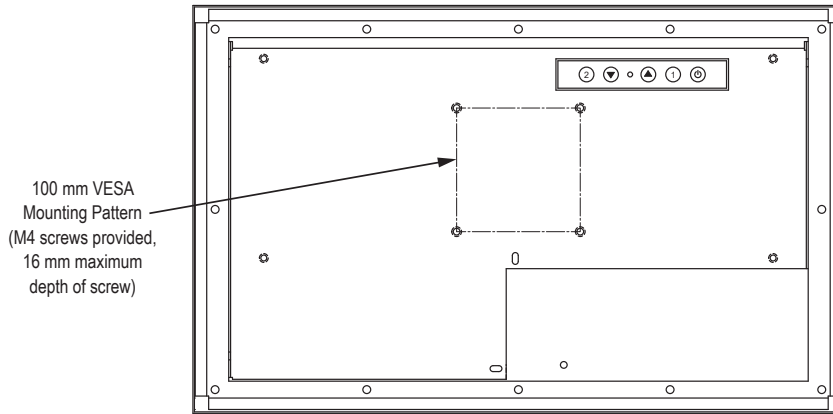

# Installation Instructions

## Step 1: Prepare for Installation



### IMPORTANT!

Perform the following steps **BEFORE** installation of the monitor into the panel.

1. Ensure that sufficient power is available.
2. Ensure that sufficient space is available to allow for proper air flow into and out of the unit.
3. Ensure that the air temperature around the unit (top and bottom) *will not exceed the rated specifications of the unit.*



- ▶ **The maximum rated temperature for the HIS-ML19.5 is 50°C (122°F).**
  - ▶ **Remember that heat rises – the temperature at the top of the cabinet will be much hotter than at the bottom if air inside the enclosure is not actively circulating. Even in a sealed enclosure, use of a circulation fan can greatly reduce temperature.**
  - ▶ **Also, remember that even though this product is designed to operate at 50°C, the life span of any electronic device is shortened when it is consistently operated at high temperatures. Therefore, it is wise to take steps to keep the temperature of the ambient air around the unit as low as possible.**
4. Ensure that the ambient humidity of the air around the unit *does not exceed the specifications of the unit.*
    - ▶ **The maximum rated humidity for the HIS-ML19.5 is 90% non-condensing.**

## Step 2: Bench-test Configuration

Make sure everything works before installing into the production environment.



**If using a KVM extender, please refer to the installation instructions included with the KVM extender module. It is particularly important to bench-test the full configuration prior to final installation. This will help to identify and troubleshoot any system issues while configuration changes may still be easily made.**

### Install Cable Connections

All monitors are shipped with a standard VGA video cable. AC-powered displays are also shipped with a power/mains cable. If you ordered a touch screen monitor, a USB cable is supplied for the touch screen interface. To use the touch screen Serial (RS-232) interface, a serial cable may be ordered separately.

The cable ports are located on the rear of the monitor. Refer to the following diagram and instructions to connect power, video, and touch screen (if applicable) to your monitor.

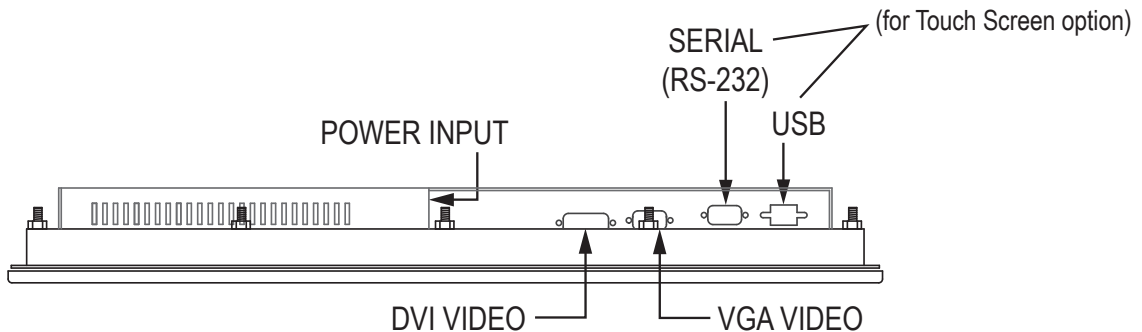



## Video Connection

The HIS-ML19.5 supports digital video through its DVI port, and analog video through its VGA port.

After selecting the appropriate interface, connect one end of your video cable to the input port on the rear of the monitor and secure the screw locks to ensure adequate strain relief. Connect the other end to the appropriate port on your host computer or other video source.



**NOTE: If this step is not performed, the product will not comply with Class I, II, III, Division 2 Hazardous Location requirements.**



### TIP!

**If the video source has an HDMI or DisplayPort connection, this can be converted for use with the DVI video port using a simple adapter.**

**If the video source has a 5 wire analog RGB video output, this can be converted for use with the VGA video port using a simple adapter.**

**Certified adapters are available from Hope Industrial Systems. Contact our sales team for more information.**

## Power Connection

The HIS-ML19.5 is available with either AC or DC power input.

AC power input models are powered by 100 to 240 VAC, 1.5/0.75 A, 60/50 Hz. Loosen the retaining clip for the power cable on the rear of the monitor. Connect the AC power cable to the power input port on the monitor then retighten the retaining clip. Connect the other end into a nearby outlet.



**NOTE: If this step is not performed, the product will not comply with Class I, II, III, Division 2 Hazardous Location requirements.**

DC power input models are powered by 9.6 to 36.6 VDC, 2.5 to 0.65 A, Class 2 or SELV/LPS.

1. With main power disconnected, hook up incoming power wires to the DC input terminal blocks according to the label markings. Securely tighten terminal block screws.
2. Plug the connector into the unit and secure by tightening the two side screws.

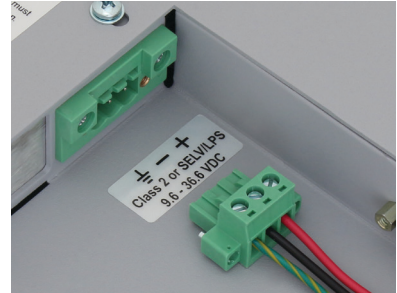

## Install Touch Screen Driver

Applies to touch screen monitors only. Instructions below apply to Windows systems. Both USB and Serial ports are present on all touch screen monitors, but only one should be used to connect the touch screen interface to the monitor.

Contact Hope Industrial Systems if you require a CD-ROM with documentation and drivers for touch screens. For a full list of downloadable drivers, please check the following Internet address:

<https://www.HopeIndustrial.com/support/drivers/>



## IMPORTANT!

**If you will be using a USB connection, *install the touch screen driver first*, and then connect the USB cable. If you will be using a Serial connection, *connect the Serial cable first*, and then install the touch screen driver.**

---

## USB Connection

1. Select the appropriate driver for your operating system from the web address listed above.
2. Click to "Run" the software when prompted. Follow on-screen instructions to download and execute the touch screen driver installation.
3. A cable retention bracket comes installed on the USB port on the rear of the monitor and will help to secure the cable and ensure adequate strain relief. Without removing

the bracket, route one end of the USB cable through the retention bracket and connect it to the USB input port on the monitor. Connect the other end to the USB port on the host computer.



**NOTE: If this step is not performed, the product will not comply with Class I, II, III, Division 2 Hazardous Location requirements.**

## Serial (RS-232) Connection

1. Connect one end of the Serial cable to the Serial input port on the rear of the monitor. Connect the other end to the Serial port on the host computer. Tighten the screw locks on the cable connectors to ensure adequate strain relief.



**NOTE: If this step is not performed, the product will not comply with Class I, II, III, Division 2 Hazardous Location requirements.**

2. Select the appropriate driver for your operating system from the web address listed above.
3. Click to "Run" the software when prompted. Follow on-screen instructions to download and execute the touch screen driver installation.

## Calibrate the Touch Screen

Once the driver has finished installing, you are ready to calibrate the touch screen. Open the Windows Control Panel and ensure the "View by" option is set to "Small icons" in the top right of the window. Click the Elo icon to open the Elo Touchscreen utility. Under the "General" tab, click the "Align" button to start the calibration routine.



### Step 3: Install into Panel

Once you have completed the full bench-test configuration and confirmed that all components are working properly, you are ready to install the monitor into its panel cutout.



### WARNING!

**Hope Industrial Systems will not assume liability for damage to internal electronics due to improper installation. Contact Hope Industrial Systems if you need additional assistance.**

1. Refer to the drawing below for the cutout dimensions for the HIS-ML19.5.

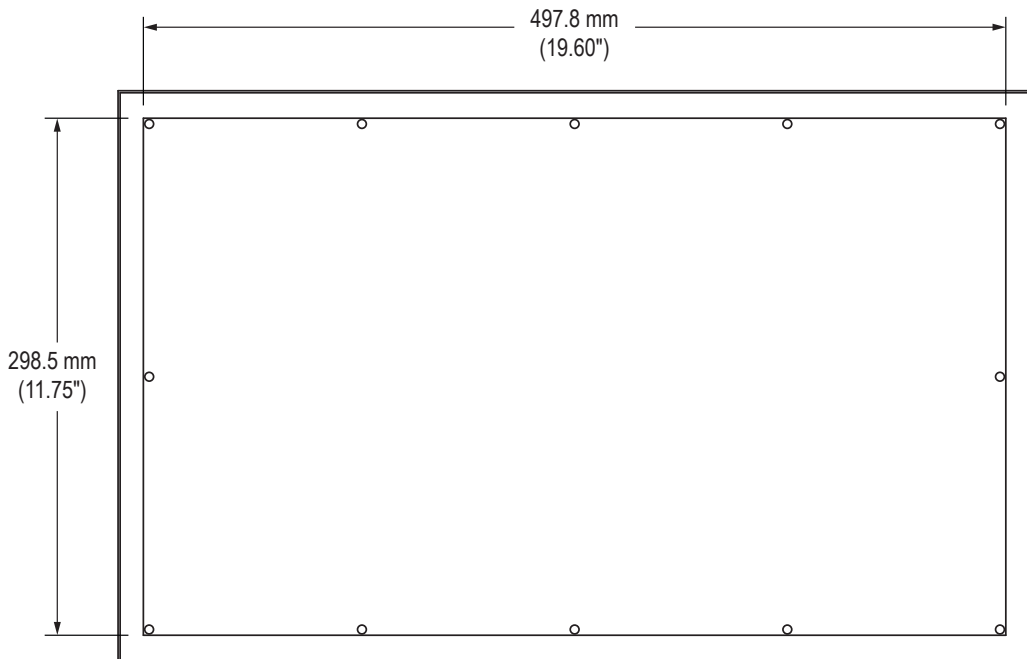

2. Locate position in panel for mounting of the monitor. Ensure that there is adequate space behind the panel. Allow extra space – 25.4 mm (1.0") behind and on each side – for air ventilation.

- Cut a rectangular hole in the panel.

► **Cutout Dimensions (W x H) for the HIS-ML19.5:**

**497.8 mm x 298.5 mm (19.60" x 11.75"); ± 0.5 mm (0.020")**

- Clean and deburr the panel hole.
- Separate the rear collar from the monitor by removing the 12 nuts.
- Refer to the enclosure mounting diagram below.

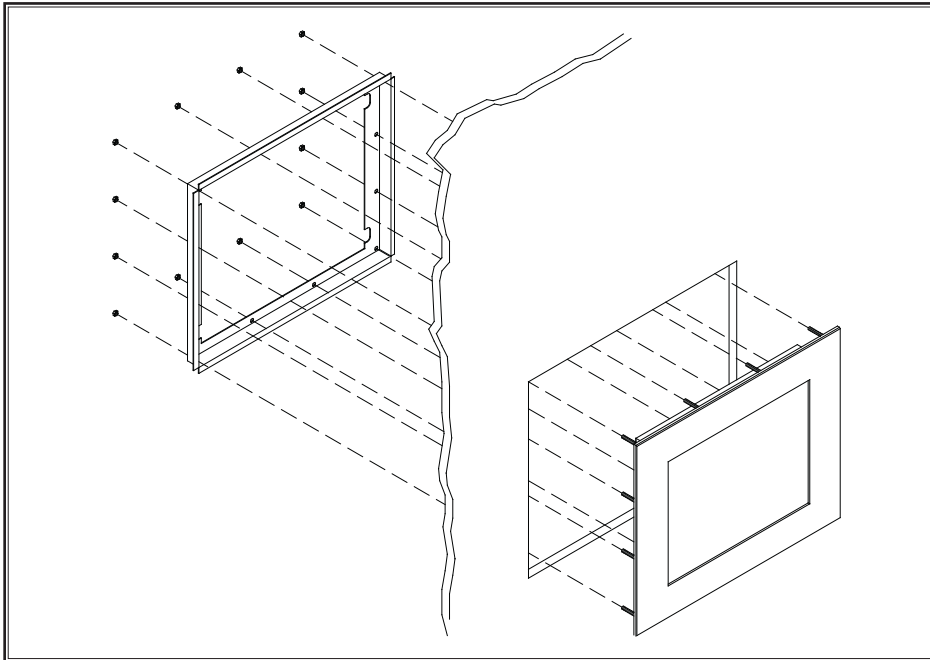

- Insert the unit into the front of the panel and re-attach the collar.

**NOTE:** Contact Hope Industrial Systems if for any reason your application does not allow for installation of the collar.

- Tighten all 12 nuts to a torque of 10-15 inch-pounds to ensure a watertight seal between the bezel gasket on the monitor and the equipment panel. Go around all nuts twice to ensure an even compression on gasket.

**NOTE:** If a torque wrench is not available, tighten all nuts evenly until bezel sits 1.6 to 2.4 mm (1/16" to 3/32") off the front of the panel.

# Video Settings

## Setting the Timing Mode

Setting the timing mode of your computer graphics adapter (or other video source) is important for maximizing the quality of the screen image and for minimizing eye strain. The timing mode consists of the resolution (e.g. 1920 x 1080) and refresh rate (or vertical frequency; e.g. 60 Hz). After setting the timing mode, use the On-Screen Display (OSD) controls to adjust the screen image.

---



### TIP!

**For the best picture quality, set your computer graphics adapter timing mode to:**

**VESA 1920 x 1080 @ 60 Hz**

---

Please refer to the computer graphics adapter manufacturer's manual for instructions on setting the resolution and timing mode. In Microsoft Windows, these settings may be found at the following location:

- ▶ **2000, XP:** Control Panel > Display > Settings
  - ▶ **Vista:** Control Panel > Personalization > Display Settings
  - ▶ **Windows 7, 8, 10:** Control Panel > Appearance and Personalization > Adjust Screen Resolution
- 



### WARNING!

**Do not set the graphics card in your computer to exceed the maximum refresh rate of 75 Hz; doing so may result in permanent damage to your display.**

---



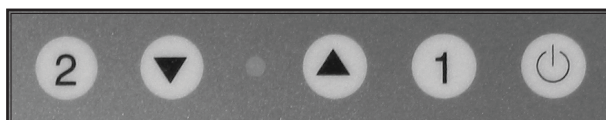
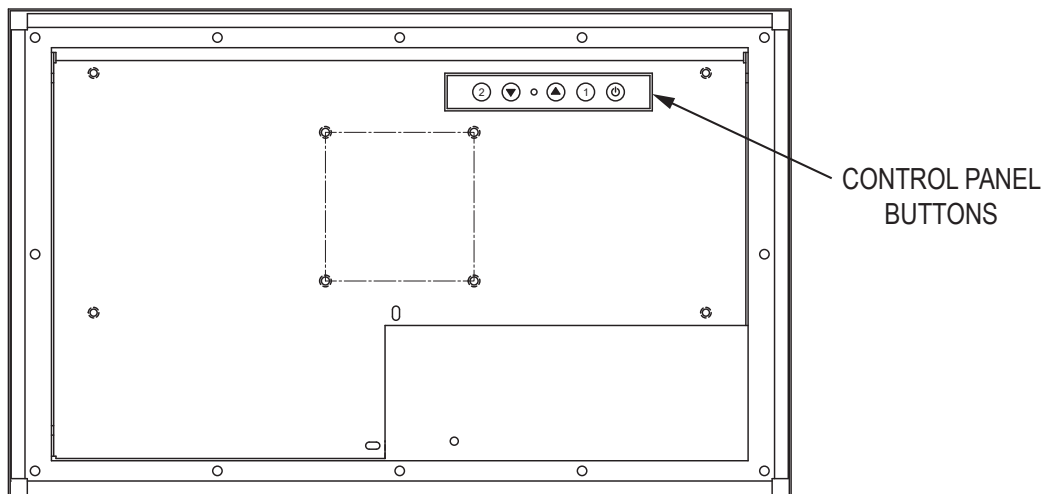

## Control Panel Buttons

Use the control panel buttons located on the back of the monitor to display and adjust various settings on the On-Screen Display (OSD) menu.



1. To display the Main Menu, press button [1].
 

**NOTE:** All OSD menus and adjustment screens disappear automatically after 15 seconds. This is adjustable through the OSD Time Out setting in the Setup menu.
2. To select a control to adjust, press the up [▲] or down [▼] button to scroll through the menu.
3. Press button [2] to open the menu for a selected control.
4. To adjust the control, press the up [▲] or down [▼] button.
5. To save the adjustments and return to the main OSD menu, press button [1] once. To exit the OSD menu, press button [1] twice.

Button	Control	Functions
	<b>Enter</b>	When the OSD menu IS NOT displayed: <ul style="list-style-type: none"> <li>• Shortcut to Auto Image Adjust.</li> </ul>
		When the OSD menu IS displayed: <ul style="list-style-type: none"> <li>• Displays the control screen for the highlighted control.</li> </ul>
	<b>Down / Blue Light Filter</b>	When the OSD menu IS NOT displayed: <ul style="list-style-type: none"> <li>• Shortcut to Blue Light Filter.</li> </ul>
		When the OSD menu IS displayed: <ul style="list-style-type: none"> <li>• Scrolls down and adjusts items in the menu down.</li> </ul>
	<b>Up / View Mode</b>	When the OSD menu IS NOT displayed: <ul style="list-style-type: none"> <li>• Shortcut to View Mode.</li> </ul>
		When the OSD menu IS displayed: <ul style="list-style-type: none"> <li>• Scrolls up and adjusts items in the menu up.</li> </ul>
	<b>Menu</b>	<ul style="list-style-type: none"> <li>• Opens the OSD menu.</li> <li>• Exits the OSD menu and saves adjustments.</li> </ul>
	<b>Power</b>	<ul style="list-style-type: none"> <li>• Turns the monitor on and off.</li> <li>• The Power Indicator light glows blue during normal operation and orange when the monitor is in Power Saving mode.</li> </ul>

## OSD and Power Lock Settings

- ▶ **OSD Lock:** Press and hold [1] and the up [▲] button for 10 seconds. If any buttons are pressed the message *OSD Locked* will display for 3 seconds.
- ▶ **OSD Unlock:** Press and hold [1] and the up [▲] button again for 10 seconds.
- ▶ **Power Button Lock:** Press and hold [1] and the down [▼] button for 10 seconds. If the power button is pressed, the message *Power Button Locked* will display for 3 seconds. With or without this setting, after a power failure, your monitor's power will automatically turn ON when power is restored.
- ▶ **Power Button Unlock:** Press and hold [1] and the down [▼] button again for 10 seconds.



## On-Screen Display (OSD) Menus

To open the OSD menu, press button [1] once. The following screen will appear:

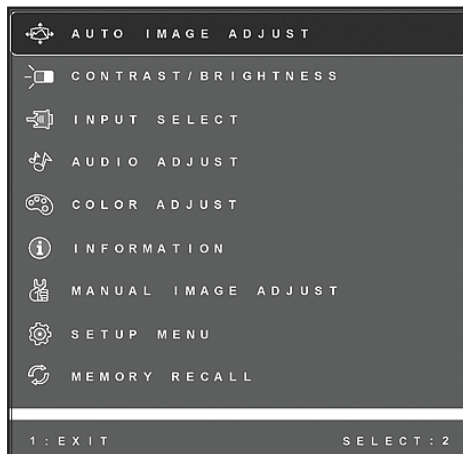

Main Menu	Description
<b>Auto Image Adjust</b>	Automatically sizes, centers, and fine tunes the video signal to eliminate waviness and distortion.
<b>Contrast / Brightness</b>	Includes the Contrast and Brightness functions.
<b>Input Select</b>	Allows the user to toggle between inputs.
<b>Audio Adjust</b>	HIS-ML19.5 monitors do not include audio capabilities; these functions are inoperative for Hope Industrial monitors.
<b>Color Adjust</b>	Provides several color adjustment modes.
<b>Information</b>	Displays the timing mode (video signal input).
<b>Manual Image Adjust</b>	Includes the H. / V. Position, Horizontal Size, Fine Tune, Sharpness, Aspect Ratio, ECO Mode, View Mode, and Blue Light Filter functions.
<b>Setup Menu</b>	Includes the Language Select, Resolution Notice, OSD Position, OSD Time Out, OSD Background, Auto Power Off, and Power Indicator functions.
<b>Memory Recall</b>	Returns adjustments back to factory settings.

## Auto Image Adjust Menu

The Auto Image Adjust menu automatically sizes, centers, and fine tunes the video signal to eliminate waviness and distortion. Press button [2] outside of the OSD menu to activate Auto Image Adjust.

**NOTE:** Auto Image Adjust works with most common video cards. If this function does not work on your display, lower the video refresh rate to 60 Hz and set the resolution to its pre-set value.

## Contrast / Brightness Menu

The Contrast / Brightness menu includes the Contrast and Brightness functions.

Contrast / Brightness Menu	Description
<b>Contrast</b>	Adjusts the difference between the image background (black level) and the foreground (white level).
<b>Brightness</b>	Adjusts the background black level of the screen image.

## Input Select Menu

The Input Select menu allows the user to toggle between inputs if there is more than one computer connected to the display. Use D-Sub for analog VGA signals and DVI for digital signals.

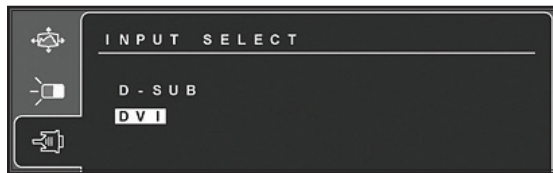

## Audio Adjust Menu

HIS-ML19.5 monitors do not include audio capabilities; these menu functions are inoperative for Hope Industrial monitors.

## Color Adjust Menu



The Color Adjust menu provides several color adjustment modes, including preset color temperatures and a User Color mode which allows independent adjustment of red (R), green (G), and blue (B). The factory setting for this product is Native.



Color Adjust Menu	Description
<b>sRGB</b>	This is quickly becoming the industry standard for color management, with support being included in many of the latest applications. Enabling this setting allows the LCD to more accurately display colors the way they were originally intended.  <b>NOTE:</b> Enabling the sRGB setting will cause the Contrast and Brightness adjustments to be disabled.
<b>Bluish</b>	Adds blue to the screen image for cooler white (used in most office settings with fluorescent lighting).
<b>Cool</b>	Adds blue to the screen image for cooler white (used in most office settings with fluorescent lighting).
<b>Native</b>	Adds red to the screen image for warmer white and richer red.
<b>Warm</b>	Adds red to the screen image for warmer white and richer red.
<b>User Color</b>	Individual adjustments for red (R), green (G), and blue (B). <ol style="list-style-type: none"> <li>1. To select color (R, G, or B) press button [2].</li> <li>2. To adjust selected color, press the up [▲] or down [▼] button.</li> </ol> <b>NOTE:</b> If you select RECALL from the OSD Main Menu when the product is set to a Preset Timing Mode, colors return to the Native factory preset.

## Information Menu

The Information menu displays the timing mode (video signal input) coming from the graphics card in the computer. See your graphics card's user guide for instructions on changing the resolution and refresh rate (vertical frequency).

**NOTE:** VESA 1920 x 1080 @ 60 Hz (recommended) means that the resolution is 1920 x 1080 and the refresh rate is 60 Hz.

## Manual Image Adjust Menu

The Manual Image Adjust menu includes the H. / V. Position, Horizontal Size, Fine Tune, Sharpness, Aspect Ratio, ECO Mode, View Mode, and Blue Light Filter functions.

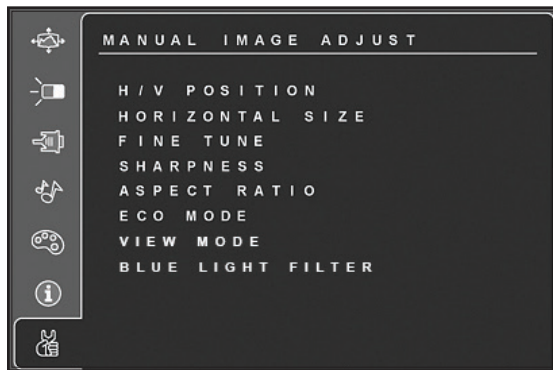

Manual Image Adjust	Description
<b>H. / V. Position</b>	Moves the screen image left or right and up or down.
<b>Horizontal Size</b>	Adjusts the width of the screen image.
<b>Fine Tune</b>	Sharpens the focus by aligning text and/or graphics with pixel boundaries. <b>NOTE:</b> Try the Auto Image Adjust function first.
<b>Sharpness</b>	Adjusts the clarity and focus of the screen image.
<b>Aspect Ratio</b>	Selects the image size for 4:3 or full screen.

Manual Image Adjust	Description
<b>ECO Mode</b>	<p>Provides lower power consumption by reducing the brightness.</p> <ul style="list-style-type: none"> <li>• <b>Standard</b> is the default brightness setting.</li> <li>• <b>Optimize</b> reduces brightness by 25%.</li> <li>• <b>Conserve</b> reduces brightness by 50%.</li> </ul>
<b>View Mode</b>	<p>Allows the user to select from five image modes to find the optimal screen setting for different applications, as well as the default "Standard" setting. This feature may also be accessed by pressing the up [▲] button outside of the OSD menu:</p> <ul style="list-style-type: none"> <li>• <b>Game</b> adjusts the gamma curve to enhance darker scenes and improve visibility in brighter scenes.</li> <li>• <b>Movie</b> adjusts the contrast to enhances the black levels.</li> <li>• <b>Web</b> adjusts the gamma curve to improve contrast and color.</li> <li>• <b>Text</b> adjusts the color temperature, contrast, and brightness of the screen for reading text.</li> <li>• <b>Mono</b> provides clearer and more obvious detail with more shades of grey, making it suited for black and white photos.</li> </ul>
<b>Blue Light Filter</b>	<ul style="list-style-type: none"> <li>• Adjusts the level of blue light emitted from the screen.</li> <li>• This feature may also be accessed by pressing the down [▼] button outside of the OSD menu.</li> </ul>

## Setup Menu



The Setup menu includes the Language Select, Resolution Notice, OSD Position, OSD Time Out, OSD Background, Auto Power Off, and Power Indicator functions.

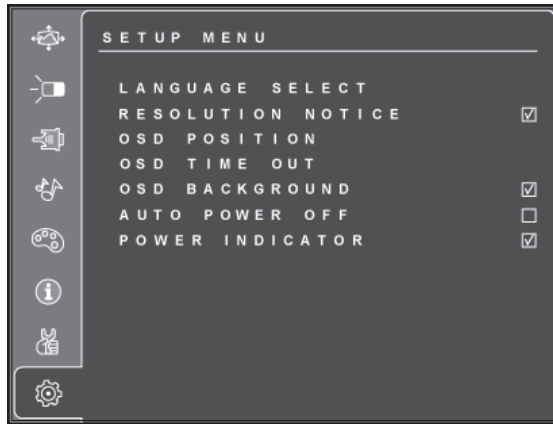

Setup Menu	Description
Language Select	Allows the user to choose the language used in the menus and control screens.
Resolution Notice	Advises the optimal resolution to use.
OSD Position	Allows the user to move the OSD menus and control screens.
OSD Time Out	Sets the length of time the OSD screen is displayed. For example, with a "15 second" time setting, if a control is not pushed within 15 seconds, the display screen disappears.
OSD Background	Allows the user to turn the OSD background On or Off.
Auto Power Off	When enabled, this setting will automatically power off the monitor when no signal is detected for 3 minutes.
Power Indicator	Allows the user to turn the Power Indicator light On or Off.

## Memory Recall Menu

The Memory Recall menu returns adjustments back to factory settings.

**NOTE:** This control does not affect changes made to the Language Select or Power Lock settings.

---

## Cleaning Instructions

---



### CAUTION!

**DO NOT USE ABRASIVE MATERIALS, SUCH AS PAPER TOWELS OR DIRTY SHOP RAGS, ON THE DISPLAY AS IT WILL SCRATCH THE PROTECTIVE COATING. ALWAYS USE A SOFT CLOTH, PREFERABLY MADE OF COTTON.**

---

All displays may be cleaned using any standard glass cleaner as long as there is no abrasive or oily content. Vinegar or ammonia will not hurt the screen.

The anti-reflective coatings on glass window-equipped displays are physically part of the surface of the glass and resist degradation to the Military Specifications.

# Troubleshooting

## Video Troubleshooting

 **IMPORTANT!**

If using a KVM extender, first try to resolve any problems using the solutions listed below. If the problem still exists, try bypassing the KVM extender. If this fixes the problem and allows the monitor to work properly, then the KVM extender is the source of the problem. Please refer to the troubleshooting section of the KVM extender manual or contact Hope Industrial Systems for additional assistance.

Symptom	Causes	Solutions
<b>No image on the screen and control's Power Indicator light is not lit</b>	Monitor is not powered on.	<ul style="list-style-type: none"> <li>Press the Power button on the monitor and make sure the Power Indicator light is lit blue.</li> <li>Check power connections at the monitor and power source.</li> <li>For DC models, check the connector polarity and ensure input voltage is 9.6 to 36.6 VDC.</li> </ul>
	The "Auto Power Off" function is enabled.	Disable this setting by unchecking the box for the "Auto Power Off" function in the OSD's "Setup" menu.
<b>No image on the screen and control's Power Indicator light is lit orange</b>	Video cable is not plugged in correctly.	Check the video cable connection at the monitor, PC, and/or KVM extender.
	PC is in Power Saving mode.	Power Saving mode can usually be exited by moving the mouse.
	PC is not powered on.	Ensure PC is powered on.
	PC is not sending signal.	Connect the PC to another known working monitor to check the PC source signal.
<b>Screen image is dim</b>	Brightness and/or contrast settings are not set properly.	Adjust the monitor's brightness and contrast settings in the OSD's "Contrast / Brightness" menu.



Symptom	Causes	Solutions
<b>"Out of Range" message box and no image on the screen</b>	The source signal exceeds the maximum resolution and/or refresh rate that the monitor can handle (> 1920 x 1080 resolution or > 75 Hz refresh rate).	Adjust the computer settings to the monitor's native resolution: 1920 x 1080 @ 60 Hz
<b>"No Signal" message box and no image on the screen</b>	Video cable is not plugged in correctly.	Check the video cable connection at the monitor, PC, and/or KVM extender.
	PC is in Power Saving mode.	Power Saving mode can usually be exited by moving the mouse.
	PC is not powered on.	Ensure PC is powered on.
	PC is not sending signal.	Connect the PC to another known working monitor to check the PC source signal.
<b>Incorrectly displayed or partial image on the screen</b>	Monitor has not been adjusted correctly for the source signal.	<ul style="list-style-type: none"> <li>• Activate the "Auto Image Adjust" function in the OSD menu.</li> <li>• Fine tune the picture by manually adjusting the image. In the OSD menu, these functions can be found in the "Manual Image Adjust" menu.</li> </ul>
<b>Wrong or abnormal colors (white is not white)</b>	Monitor color settings are incorrectly adjusted.	Reset the monitor to the factory default settings by activating the "Memory Recall" function in the OSD.
	Video cable is not securely connected.	If any colors (red, green, or blue) are missing, check the video cable to make sure it is securely connected.
	Video cable is bad.	Check to make sure there are no loose or broken pins in the cable connector. Shorts in the cable could also cause an improper image to display.
<b>The message "OSD Locked" appears</b>	The OSD has been locked to prevent unauthorized changes to display settings.	Press and hold [1] and the up [▲] button for 10 seconds.
<b>The message "Power Button Locked" appears</b>	The Power button has been locked to prevent unauthorized shut down of the monitor.	Press and hold [1] and the down [▼] button for 10 seconds.



## Touch Screen Troubleshooting

Applies to touch screen monitors only. To be sure that you have the most current driver, please check the following Internet address:

<https://www.HopeIndustrial.com/support/drivers/>

Symptom	Causes	Solutions
<b>No response when touching the touch screen</b>	Touch screen driver has not been installed.	Download and install the latest driver from the Hope Industrial website.
	Touch screen cable is not plugged in correctly.	Make sure either the USB or Serial cable is securely connected to the monitor and PC. Do not connect both.
	If using a USB connection, does the USB cable length exceed 5 meters?	USB cables have a 5 meter limitation and could cause no touch response if this is exceeded.
	If using a Serial connection, is the Serial cable plugged into the correct COM port?	Ensure that the Serial cable is connected to the COM port being used prior to installing the touch screen driver.
<b>The cursor moves but does not follow my finger when touching the touch screen</b>	Touch screen driver has not been installed.	Download and install the latest driver from the Hope Industrial website.
	Touch screen has not been calibrated.	<p>Activate the calibration utility. In Windows systems, these settings may be found at the following location:</p> <p>Control Panel &gt; Elo Touchscreen &gt; "General" Tab</p> <ul style="list-style-type: none"> <li>• Press the Align button.</li> <li>• Touch all targets as the appear to calibrate the touch screen.</li> <li>• Press the Green Check button when verified.</li> </ul>



## Specifications

Display	
Type	Thin-film transistor (TFT) Active Matrix Liquid Crystal
Size	19.5" diagonal
Image Size (W x H)	434.88 mm x 238.68 mm (17.1" x 9.4")
Native Resolution	Full HD 1080p (1920 x 1080, 16:9 aspect ratio)
Minimum Resolution	VGA (640 x 480)
Pixel Pitch	0.2265 mm x 0.221 mm
Number of Colors	16.7 million
Brightness (white)	250 nits (cd/m <sup>2</sup> )
Viewing Angle (Hori/Vert)	178° / 178°
Contrast Ratio (typical)	3000:1 (static)
Backlight (typical)	LED; 50,000 hour brightness half-life

Environmental	
Operating Temperature	0° to 50°C (32° to 122°F)
Storage Temperature	-20° to 60°C (-4° to 140°F)
Humidity	20% to 90% non-condensing
Operating Shock	15 g, 6 msec, half-sine
Operating Vibration (sine)	1.0g, swept sine 9 – 500 Hz
Transport Vibration (random)	0.1g <sup>2</sup> / Hz, 10 – 200 Hz 0.03g <sup>2</sup> / Hz, 200 – 2000 Hz
Altitude	<ul style="list-style-type: none"> <li>Operating: up to 10,000 feet</li> <li>Non-operating: up to 40,000 feet</li> </ul>

<b>Video</b>	
<b>Input Connectors</b>	<ul style="list-style-type: none"> <li>HD-15, DVI-D</li> <li>Compatible inputs using optional adapter (contact Hope Industrial Systems for details):               <ul style="list-style-type: none"> <li>HDMI (via HDMI to DVI adapter)</li> <li>DisplayPort (via DisplayPort to DVI adapter)</li> <li>BNC (via HD-15 to 5-wire BNC adapter)</li> </ul> </li> </ul>
<b>Input Signal Formats</b>	<ul style="list-style-type: none"> <li>RGB Analog video, 0.7/1.0 Vp-p, 75 Ohms</li> </ul> <p>Compatible sync modes: Separate H/V sync, Composite sync, Sync on Green</p> <ul style="list-style-type: none"> <li>DVI</li> </ul> <p><b>NOTE:</b> NTSC/PAL composite input available (call for details)</p>
<b>Horizontal Scan</b>	24 – 82 kHz
<b>Vertical Scan</b>	50 – 75 Hz
<b>Supported Video Standards</b>	<ul style="list-style-type: none"> <li>1920 x 1080 @ 60 Hz</li> <li>1680 x 1050 @ 60 Hz</li> <li>1600 x 1200 @ 60 Hz</li> <li>1400 x 1050 @ 60 Hz</li> <li>1440 x 900 @ 60, 75 Hz</li> <li>1280 x 1024 @ 60, 75 Hz</li> <li>1280 x 960 @ 60 Hz</li> <li>1280 x 720 @ 60 Hz</li> <li>1152 x 870 @ 75 Hz</li> <li>1024 x 768 @ 60, 70, 75 Hz</li> <li>832 x 624 @ 75 Hz</li> <li>800 x 600 @ 56, 60, 72, 75 Hz</li> <li>720 x 400 @ 70 Hz</li> <li>640 x 480 @ 60, 67, 72, 75 Hz</li> </ul>
<b>Response Rate (typical)</b>	20 ms

Electrical	
Monitor Input	<ul style="list-style-type: none"> <li>AC power models – 100 to 240 VAC, 1.5/0.75 A, 60/50 Hz</li> <li>DC power models – 9.6 to 36.6 VDC, 2.5 to 0.65 A, Class 2 or SELV/LPS</li> </ul>
Power Consumption	~ 20 W
Power Consumption (Standby mode)	< 1 W

Functional	
Control Panel Buttons	2 (Enter), Down, Up, 1 (Menu), Power
On-Screen Display (OSD) Menus	Auto Image Adjust, Contrast / Brightness, Input Select, Audio Adjust, Color Adjust, Information, Manual Image Adjust, Setup Menu, Memory Recall
Touch Screen Option	5-wire resistive system; emulates a mouse; Serial (RS-232) and USB interface to host computer

Physical	
Enclosure Type	Panel mount; rear collar compresses gasket against panel (5/16" maximum panel thickness); held by 12 M5 studs
Panel Rating (with proper installation)	Built to IP65/IP66 standards <ul style="list-style-type: none"> <li>NEMA/UL Type 12/4 (Black Powder-Coated Faceplate)</li> <li>NEMA/UL Type 12/4/4X (Stainless Steel Faceplate)</li> </ul>
Depth	<ul style="list-style-type: none"> <li>Total Product Depth – 57.2 mm (2.25")</li> <li>Depth Behind Front Edge of Panel – 50.0 mm (1.97")</li> </ul> <p><b>NOTE:</b> Design to maximum depth of 69.0 mm (62.0 mm behind front edge of panel) to ensure future compatibility with later revisions and replacement units.</p>
Front Bezel Outside Dimensions (W x H x D)	527.0 mm x 330.2 mm x 7.1 mm (20.75" x 13.00" x 0.28") (not including gasket)
Cutout Dimensions (W x H)	497.8 mm x 298.5 mm (19.60" x 11.75"); ± 0.5 mm (0.020")
Net Weight	6.8 kg (15 lbs.)
Shipping Weight	9.07 kg (20 lbs.)

<b>Compliances and Certifications</b>	
<b>Electrical</b>	<ul style="list-style-type: none"> <li>UL 60950 3<sup>rd</sup> Edition / cUL Recognized Component (File No. E212889)</li> <li>UL 508A Listed (File No. E318630)</li> <li>FCC Class A</li> <li>CAN ICES-3A/NMB-3A</li> <li>CE</li> <li>UKCA</li> <li>NOM (Registration No. NOM-019-SCFI-1998)</li> </ul>
<b>Environmental</b>	<ul style="list-style-type: none"> <li>IEC 60721-3 (Reliability)</li> <li>WEEE (Registration No. WEE/DJ1859ZX for UK only)</li> </ul>
<b>Enclosure</b>	UL 50E (File No. E318630)
<b>Hazardous Location</b>	UL Rated for Hazardous Locations: Industrial Control Equipment for Hazardous Location: Listed for Class I, Division 2 for Groups A, B, C, and D; Class II, Division 2 for Groups F and G; Class III; Temp Code T4A (File No. E328481) per UL121201-2017 and CAN/CSA C22.2 No. 213-17



---

# Warranty Statement

## **Who is Covered?**

This warranty covers the purchaser of this product only and is not transferable without our written consent.

## **What Does This Warranty Cover and What is the Period of Coverage?**

We warrant this product to be free from defects in material and workmanship, subject to the conditions set forth below. The warranty on all industrial display and keyboard products, KVM2 extender series, and ENCL-TC/ENCL-PC enclosure series remains in force for a five year period beginning on the date we invoice you. If Hope Industrial Systems repairs or replaces a product under warranty, its warranty term is not extended.

## **What Will We Do to Correct Problems and How Do You Get Service?**

We will repair or replace (at our sole option) any part of the unit which proves to be defective. Replacement parts may be new or refurbished and will meet the same specifications of the original parts or unit. For orders sold through our U.S. operations, at our expense we will return the product to any location within the U.S.A. via the shipping method of our choice. Shipping fees for products returned to customers outside the U.S.A. are the responsibility of the customer. For products originally sold through Hope Industrial U.K., return shipping to and from Hope Industrial repair facilities and any EU member country (except Croatia, Cyprus, and Malta) will be provided using a pre-paid UPS shipping label sent via email. In order to receive warranty service you must get prior approval from Hope Industrial Systems. To request warranty service you can telephone us at +1 678 762 9790 or +44 (0) 20 7193 2618 in the United Kingdom or send an email to support@HopeIndustrial.com. If we determine that warranty service is needed we will give you a Return Material Authorization (RMA) number. This RMA number must be conspicuously marked on the outside of the shipping box. Hope Industrial Systems will not accept shipments not accompanied by the RMA number. Except where otherwise noted, you must ship or deliver the product to Hope Industrial Systems Freight prepaid.

## **What Does This Warranty Not Cover?**

This warranty does not cover equipment which has been damaged due to misuse, abuse, or accident such as: operating the equipment outside of published specifications; exposure to chemicals or gases not covered by specified NEMA standards; displaying fixed images for long periods of time resulting in afterimage effects; improper or unauthorized repair by anyone other than Hope Industrial Systems or a service agency authorized by Hope Industrial Systems to perform such repairs; fire, flood, "acts of God", or other contingencies beyond the control of Hope Industrial Systems.

Hope Industrial Systems' responsibility for malfunctions and defects in hardware is limited to repair and replacement as set forth in this warranty statement. Hope Industrial Systems shall not be liable for direct, indirect, incidental, consequential, or other types of damages resulting from the use of any Hope Industrial Systems product other than the liability stated above. These warranties are in lieu of all other warranties express or implied, including, but not limited to, the implied warranties of merchantability or fitness for a particular purpose. Some states do not allow the exclusion of implied warranties or the limitation or exclusion of liability for incidental or consequential damages so the above exclusions or limitations may not apply to you. You are cautioned that the performance of this product can be affected by many factors, such as system configuration, software, application, and operator control of the system. It is your responsibility to determine suitability of this product for your purpose and application.

# Hope Industrial Systems, Inc.

## US / International

1325 Northmeadow Parkway, Suite 100  
Roswell, GA 30076  
United States

**Toll Free:** (877) 762-9790 | **International:** +1 (678) 762-9790 | **Fax:** +1 (678) 762-9789

**Sales and Customer Service:** [sales@HopeIndustrial.com](mailto:sales@HopeIndustrial.com)

**Support and Returns:** [support@HopeIndustrial.com](mailto:support@HopeIndustrial.com)

**Accounting Department:** [accounting@HopeIndustrial.com](mailto:accounting@HopeIndustrial.com)

[www.HopeIndustrial.com](http://www.HopeIndustrial.com)

### EU Authorized Representative:

Falcons Logistics B.V.  
Hoeksteen 26 F  
2132 MS Hoofddorp  
Netherlands

[HopeIndustrial.eu](http://HopeIndustrial.eu)

### United Kingdom Authorized Representative:

Falcon AR Services UK LTD  
Lynton House  
7-12 Tavistock Square  
WC1H 9LT London  
United Kingdom

[HopeIndustrial.co.uk](http://HopeIndustrial.co.uk)

**Phone:** +44 (0) 20 7193 2618 | **Fax:** +44 (0) 20 7117 1194

**Sales and Customer Service:** [sales@HopeIndustrial.co.uk](mailto:sales@HopeIndustrial.co.uk)

**Support and Returns:** [support@HopeIndustrial.co.uk](mailto:support@HopeIndustrial.co.uk)

**Accounting Department:** [accounting@HopeIndustrial.co.uk](mailto:accounting@HopeIndustrial.co.uk)

### France

Phone: +44 (0) 20 7193 2618

[HopeIndustrial.fr](http://HopeIndustrial.fr)

### Italy

Phone: +39 80 0740414

[HopeIndustrial.it](http://HopeIndustrial.it)

### Germany

Phone: +44 (0) 20 7193 2618

[HopeIndustrial.de](http://HopeIndustrial.de)

### Spain

Phone: +34 91 1438229

[HopeIndustrial.es](http://HopeIndustrial.es)

